



TICA Central Air Conditioner
DIGITAL VARIABLE-CAPACITY DX
AIR HANDLING UNIT

Purifying Air Conditioner for Clean Operating Room
Constant Temperature and Humidity Fresh Air Handling Unit
Precision Constant Temperature and Humidity Air Conditioner
Low Temperature Deep Dehumidification Air Conditioner

FORM NO.B7520G01

Established in 1991

TICA is a professional enterprise specialized in R&D, manufacturing, sales and services of environment cleaning and thermal energy utilization.

TICA is a national high-tech enterprise, a single leading enterprise cultivated by the Ministry of Industry and Information Technology, a national brand cultivation enterprise of the Ministry of Industry and Information Technology, and a vice chairman member of China Refrigeration and Air-conditioning Industry Association. It has a national-recognized enterprise technology center, an enterprise academician workstation, and a post-doctoral research workstation. Its projects cover Beijing Bird's Nest Stadium, Water Cube, Wukesong Indoor Stadium, PetroChina, Sinopec, State Grid, Nanjing Panda, Hangzhou Xiaoshan International Airport, Hainan Airlines Group, Shangri-La Hotel, Manila Ocean Park, Abu Dhabi Al Muneera, SM City in Philippines and Unilever, etc.

TICA is also the outstanding provider of central air conditioners for China's subway networks and has successfully served nearly 60 key subway lines in major cities such as Beijing, Shanghai, Guangzhou, Shenzhen, Chengdu, Suzhou, Hangzhou and Tianjin. TICA is a professional supplier and service provider in China that specializes in system integration of clean environment. While for microelectronics, hospital operating rooms, biopharmaceutical industry and other professional purification areas, our market share has achieved over 40% in each.

TICA Quality For IAQ

TICA focuses on indoor air quality (IAQ) in clean environments. Product lines include return air purifiers, heat recovery ventilators, fresh air purifiers, air purifiers, as well as the clean air handling units and digital variable-capacity air handling units used in the professional purification field. Regarding core technology, TICA established an ISO class 1 super-clean environment integration system and won the first prize of CMIST.

In the field of thermal energy utilization, TICA's product lines include modular chillers, VRF units, screw chillers, centrifugal chillers, and ORC low-temperature waste heat power generation systems. In 2015, TICA and United Technologies Corporation (UTC) established a global strategic joint venture cooperation relationship and acquired PureCycle, an ORC low-temperature power generation company owned by Pratt & Whitney under UTC. TICA obtained PureCycle trademarks and more than 100 patents and national copyrights. TICA's efficient centrifugal chillers, water-cooled screw chillers, and air-cooled screw chillers are manufactured with the technical license of Carrier under UTC.

TICA is characterized by excellent system integration capability. In the application of "Efficient Refrigeration System of Underground Railway Station", the integrated COP of the refrigeration room amounts to 6.0, and the research achievement reaches the international advanced level. In 2018, TICA merged and acquired an OFC central air conditioning enterprise **SMARTD**. TICA's excellent system integration capability and the **SMARTD** world-class OFC water chillers help increase the integrated COP of the efficient equipment room to 6.7 to 7.0.

TICA---We're striving.

TICA aims to build itself into a world-leading system integration supplier and service provider that specializes in clean environment and thermal energy utilization.



About TICA	1
Nomenclature and Product Features	2
Digital Variable-Capacity Unit for Clean Operating Room	4
Constant Temperature and Humidity Fresh Air Handling Unit	8
Precision Constant Temperature and Humidity Air Conditioner	12
Low Temperature Deep Dehumidification Air Conditioner	13
Air Conditioner for Rapid Cooling of a Cardiac Surgery Operating Room	14
ODU Specifications	15
IDU Air Flow Table and Electrical Diagram	16
Five-year Warranty	17
Unit Installation and Reference Projects	18

TICA owns five production sites in Nanjing, Tianjin, Guangzhou, Chengdu and Kuala Lumpur, and a network of over 70 sales and service filiales around the world.

Its Nanjing HQ base received 3-star certification for national No. 001 green industrial construction.



Malaysia Base



Nanjing Headquarter



Tianjin Base



Guangzhou Base



Chengdu Base

Nomenclature and Product Features

Nomenclature

IDU

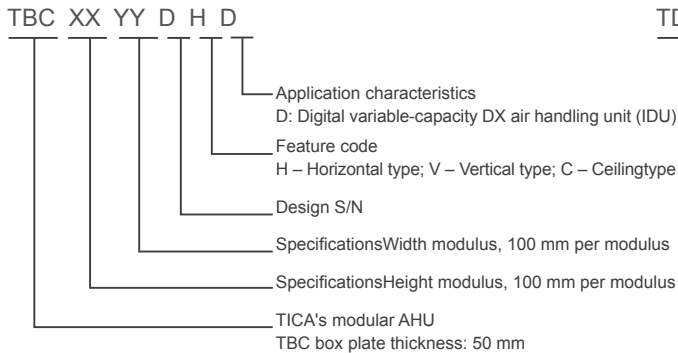

ODU

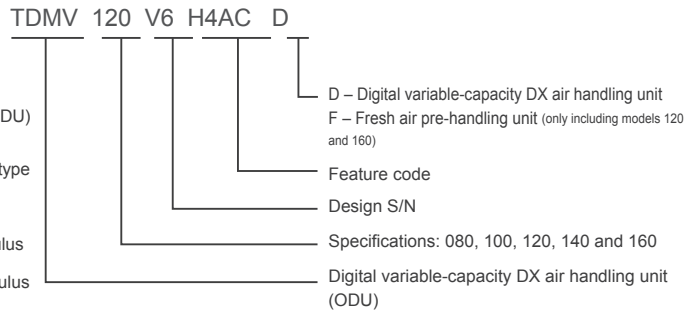

Product features

Cutting-edge digital variable-capacity technology

The unit is equipped with Emerson's world-leading digital variable-capacity compressor that won the innovation award from ARI. The compressor controls the movement of its scroll within a very narrow range via control of the action and time of PWM valve, and changes the rise and engagement of the fixed scroll to regulate the cycle time of "load" and "unload" and therefore to implement varying capacity and control of the capacity output (continuously adjustable in the range of 10-100%).

Precise regulation

To ensure precision, full consideration is given when selecting every component of the unit, such as compressor, EXV, fan and controller. In addition, the temperature for cooling operation is extended to -5°C at the lowest, possibly allowing cooling at a low ambient temperature.

Stable operation with little fluctuation

For an average direct expansion unit with Boolean controls, the supply air temperature is likely to deviate from the setpoint at partial load, thus resulting in undesired temperature and humidity indoors. In contrast, the digital compressor features stepless capacity regulation with the range of 10-100%, and therefore ensures precise control of supply air temperature. Even under the worst operating conditions, such as fluctuating fresh air conditions, variable air flow and low load, the unit is able to operate reliably and maintain stable control of temperature and humidity.

Energy-efficient solution

For an average direct expansion unit with Boolean controls, redundant control is implemented, which means possible excessive cooling and dehumidification at partial load, and, where necessary, reheating and rehumidification compensation is required.

By comparison, the digital variable-capacity technology supports 10-100% stepless regulation and precise cooling capacity output with no waste. Compared with the fixed capacity unit with four-grade regulation, the digital variable-capacity direct expansion unit saves 20% of the energy at the same load.

Environment-friendly

R410A refrigerant does not contribute to ozone depletion and is unlikely to be phased out.

The digital compressor achieves variable-capacity with purely mechanical components and therefore is EMC-friendly with no interference to medical devices and precision instruments.

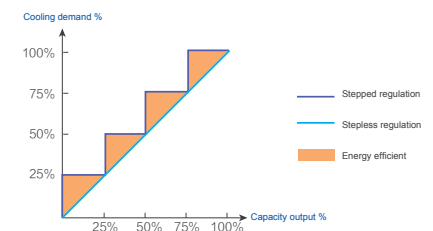
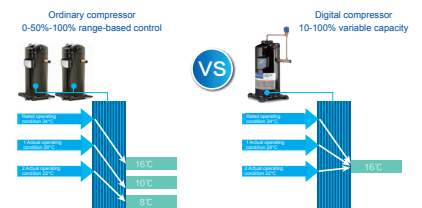
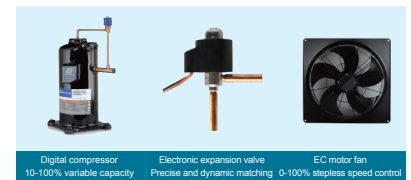



Powerful regulation capacity and excellent low-temperature cooling performance
Digital variable-capacity DX air handling unit is widely applied in multiple industries

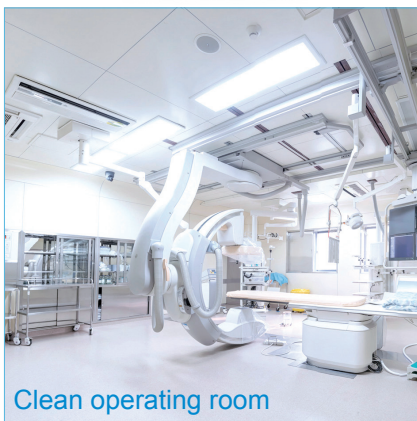

Clean operating room



Inspection and quarantine



Medical laboratory

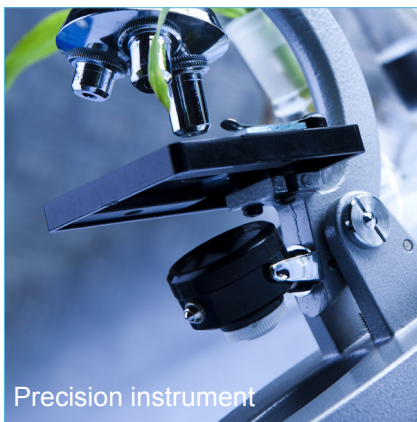

Precision instrument

DIGITAL VARIABLE-CAPACITY DX AIR HANDLING UNIT

Wide application



Biosafety laboratory



Pharmaceutical industry



Food processing



Lithium battery manufacture

Digital Variable-Capacity Unit for Clean Operating Room

Advantages over conventional purifying air conditioners for clean operating room

1. Simplified O&M

Problems: Complicated system components such as the cooling tower, water pump, water chiller, pipeline, and various valves need to be maintained, which is heavily mandated. Also, improper maintenance may fail to meet the designed temperature and humidity requirements.

Solutions: The adoption of a simple system features IDU, ODU, and the refrigerant pipe and control cable between them. It requires no water pump, valve, filter, or water tank, greatly reducing the maintenance workload. The simpler the system, the easier the performance is guaranteed.

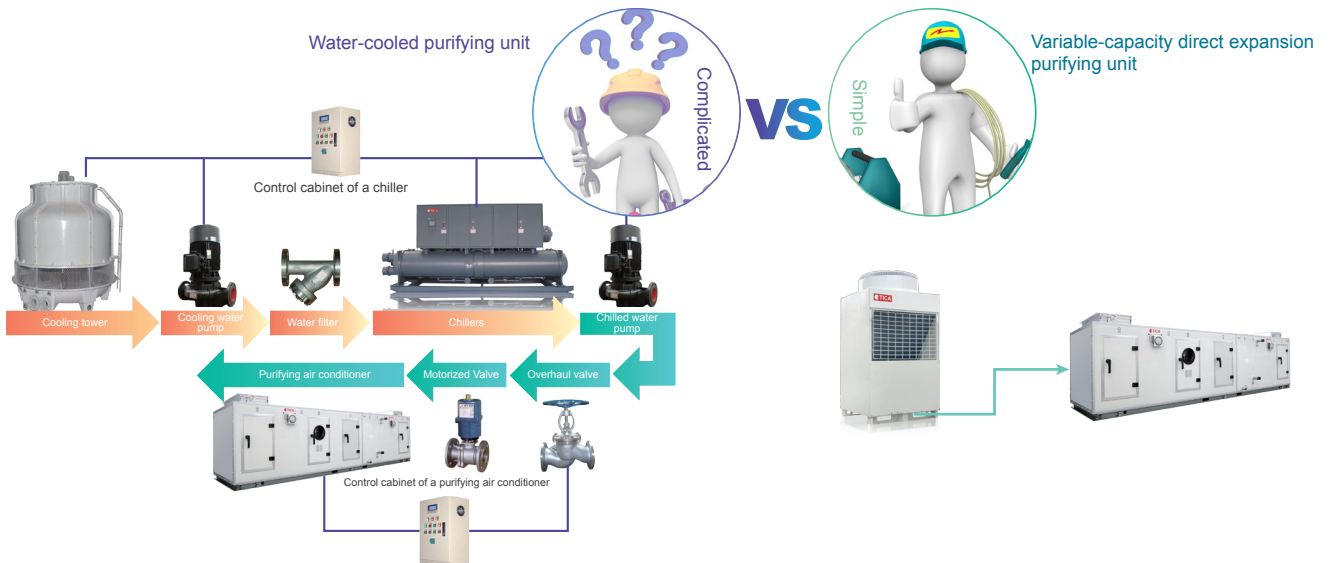

2. More stable control of temperature and humidity

Problems: Over a period of time, the cold water supply temperature increases to 10°C or even higher for installation and O&M reasons, rather than the rated 7°C. This makes the unit fail to meet dehumidification requirements and would result in excessive humidity indoors.

Solutions: The refrigerant direct expansion system uses low-temperature refrigerant directly to cool and dehumidify the air (2°C refrigerant → air), without secondary heat exchange (2°C refrigerant → 7°C cold water → air) of the cold water air conditioner, so the dehumidification performance is far superior to that of the cold water system. The humidity can be maintained within the set range and there is no need to worry about excessive humidity due to water temperature fluctuation.

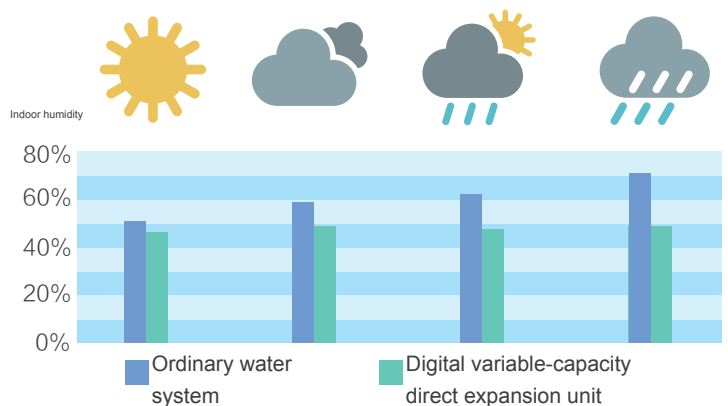

3. Energy-efficient humidity priority control mode

Problems: For an average purifying unit, temperature rise is carried out after temperature drop and dehumidification, resulting in high power consumption in the air conditioning system.

Solutions: TICA's digital variable-capacity unit for clean operating room uses the humidity priority control mode recommended by the Architectural Technical Code for Hospital Clean Operating Department (GB50333-2013), allowing fresh air deep dehumidification and temperature control by a circulating air unit and avoiding offset between cooling and heating.

Compliance with national standard for more efficient operation

According to Article 8.1.6 of the Architectural Technical Code for Hospital Clean Operating Department (GB50333-2013), when conditions permit, humidity priority control mode should be adopted. The fresh air unit dehumidifies the operating room while the circulating air unit cools down the operating room at a dry state. In this way, it put an end to energy waste caused by conventional solutions of heating following cooling and dehumidifying processes.

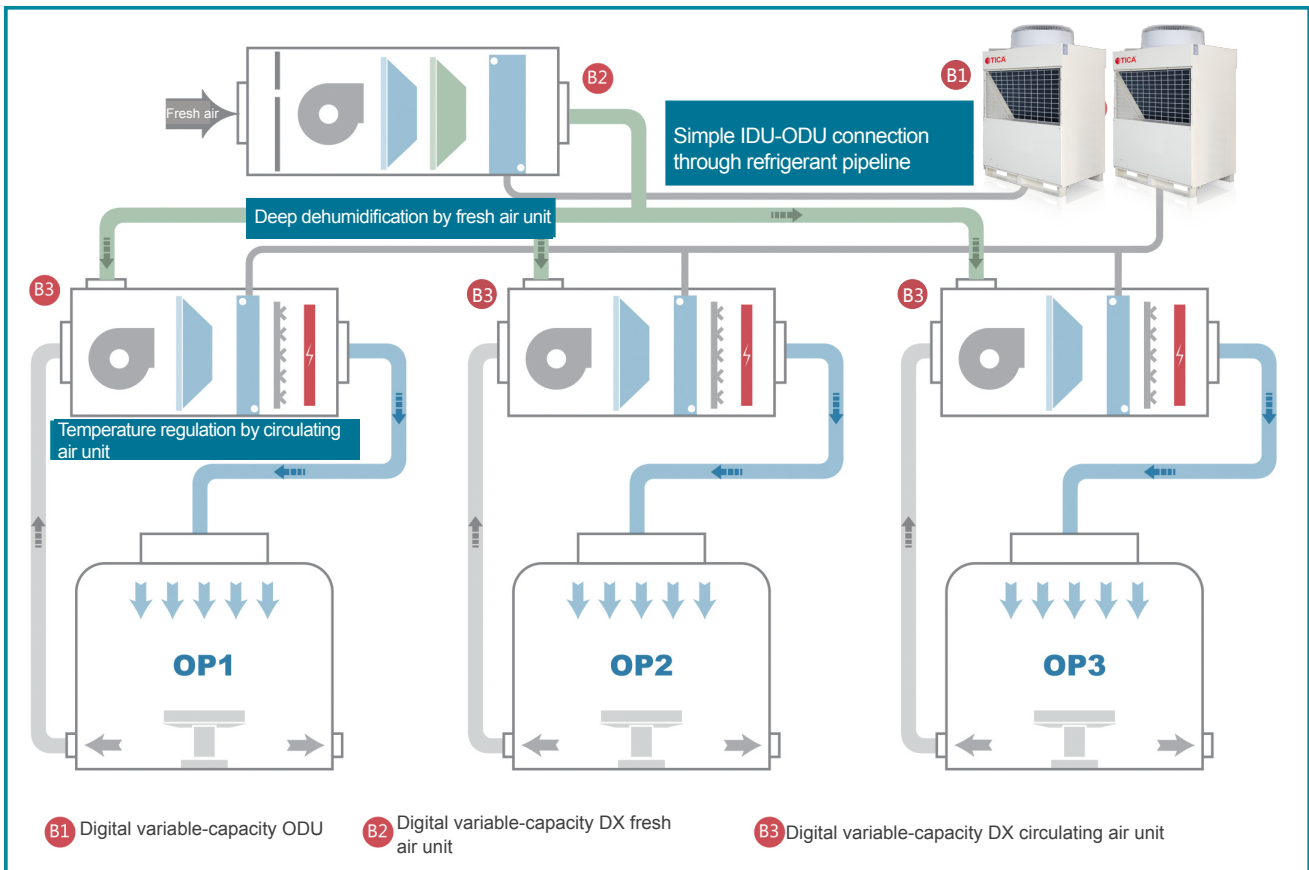

An example of a clean operating room

Operating room level	Total energy consumption of traditional primary air return scheme	Total energy consumption of digital direct expansion unit with separate control of temperature and humidity	Energy efficiency ratio
Grade I	82.6kw	19.8kw	76%
Grade II	45.2kw	15.7kw	65%
Grade III	27.0kw	15.1kw	44%
Grade IV	20.3kw	11.9kw	41%

Safe and reliable

The ODU of the fresh air unit features a combination of multiple modules, which allows that even if one module requires maintenance, the remaining modules of the unit could still operate normally.



Parameters of fresh air deep dehumidification and purification air conditioner for clean operating room

Model	TBC	0711	0711	0711	1012	1012	1012	1012
Air flow	CMH	2000	2300	3000	3400	4500	5000	7000
ESP	Pa	600						
Typical function section configuration 1: air inlet, primary efficiency filter, fan, flow equalization, medium efficiency filter, sub-high efficiency filter, direct expansion and dehumidification, and air outlet								
Typical function section configuration 2: air inlet, primary efficiency filter, direct expansion and pre-dehumidification, fan, flow equalization, medium efficiency filter, sub-high efficiency filter, direct expansion and re-dehumidification, and air outlet								
Cooling capacity	kW	36	43	56	64	86	96	129
Rated air supply moisture		8 g/kg						
Recommended ODU models	TDMV***V6H4ACF	-	-	-	-	-	120*2	160*2
	+							
	TDMV***V6H4ACD	140	160	100*2	120*2	160*2	120	160

Notes:

1. The configuration and parameters of function section can be adjusted depending on the situation;
2. When the fresh air temperature is low, the heat pump unit needs to preheat the inlet air to at least 5°C;
3. When the dry bulb temperature of fresh air is below -10°C, it is not recommended to use heat pump unit.

Purifying air conditioner for grade-I operating room

Model	Air flow (m ³ /h)	External static pressure (Pa)	Cooling capacity (kW)	Electrode humidifying capacity (kg/h)	Electric heating power (kW)
TBC1012	10000	650	8	10	18

Function section: Mixing, direct expansion, secondary air return, fan, flow equalization, medium efficiency filter, electrode humidification, and electric heating air outlet

Purifying air conditioner for grade-II operating room

Model	Air flow (m ³ /h)	External static pressure (Pa)	Cooling capacity (kW)	Electrode humidifying capacity (kg/h)	Electric heating power (kW)
TBC0808	3500	650	5	8	12

Function section: Mixing, fan, flow equalization, primary and medium efficiency filter, direct expansion, electrode humidification, and electric heating air outlet

As grade-III and grade-IV operating rooms require less air quantity, two or three such rooms may share one purifying air conditioning unit

Model	Air flow (m ³ /h)	External static pressure (Pa)	Cooling capacity (kW)	Electrode humidifying capacity (kg/h)	Electric heating power (kW)	Applicable Scope
TBC0808	2000	650	5	5	6	One grade-IV room
TBC0808	2500	650	5	5	8	One grade-III room
TBC0808	3000	650	10	8	9	Two grade-IV rooms
TBC0810	4000	650	10	8	12	One grade-III room + one grade-IV room
TBC0810	4500	650	15	15	14	Three grade-IV rooms
TBC0810	5000	650	10	8	15	Two grade-III rooms
TBC1012	5500	650	15	15	17	One grade-III room + two grade-IV rooms
TBC1012	6500	650	15	15	20	Two grade-III rooms + one grade-IV room
TBC1012	8000	650	15	15	24	Three grade-III rooms

Typical function section: Mixing, fan, flow equalization, primary and medium efficiency filter, direct expansion, electrode humidification, and electric heating air outlet

Purifying air conditioner for auxiliary room

Model	Air flow (m ³ /h)	External static pressure (Pa)	Cooling capacity (kW)	Electrode humidifying capacity (kg/h)	Electric reheating power (kW)	Applicable area of auxiliary room
TBC0808	3000	650	10	5	9	≤120m ²
TBC0810	4000	650	12	8	12	150m ²
TBC0810	5000	650	15	8	15	200m ²
TBC1012	6000	650	20	15	18	250m ²
TBC1012	8000	650	28	15	24	350m ²
TBC1317	10000	650	32	25	30	400m ²
TBC1317	12000	650	40	25	36	500m ²

Typical function section: Mixing, fan, flow equalization, primary and medium efficiency filter, direct expansion, electrode humidification, and reheating air outlet

Note:

The parameters and configuration of the above purifying air conditioners can be adjusted depending on the situation.

Constant Temperature and Humidity Fresh Air Handling Unit

Animal lab, labs of pathology/laboratory medicine, Pharmacy Intravenous Admixture Services (PIVAS), PCR lab, and obstetric operating room, etc. typically use full fresh air purifying system to provide large quantities of fresh air. Although such practice avoids cross-contamination, it is also energy-intensive; the above scenarios also pose high requirements on indoor temperature and humidity, and has significantly varying fresh air conditions during the year, hence requiring the purifying air conditioner to be very adaptive;



Preparation lab



Animal lab



PIVAS

General technical requirements for places where constant temperature and humidity fresh air handling unit is installed

No.	Industry	Fresh Air Ratio	Application Site	Min. Air Replacement Times	Temperature Requirement (°C)	Humidity Requirement
1	Medical	100%	Pathological examination	12 or 15	18-25	45%~65%
2		100%	Infection control	12 or 15	18-25	45%~65%
3		100%	Preparation lab	12 or 15	18-25	45%~65%
4		100%	PIVAS	12 or 15	18-25	45%~65%
5	Center for Disease Control (CDC)	100%	PCR lab	12 or 15	18-25	45%~65%
6	Pharmacy	100%	Animal lab (ABSL, BSL)	12 or 15	18-25	45%~65%
7		100%	Microbiology lab	25	18-26	45%~65%
8	Inspection and quarantine	100%	Inspection and quarantine lab (e.g. DNA lab)	12 or 15	18-25	45%~65%
9	Public security organs	100%	Inspection and quarantine lab (e.g. DNA lab)	12 or 15	18-25	45%~65%

Note:

The specific parameters are subject to the design data of the professional design institute. The parameters listed above are for reference only.

TICA's constant temperature and humidity DX fresh air handling unit uses one- or two-tier direct expansion coil to implement energy allocation and regulation in a scientific and cost-effective manner, making the unit a perfect choice for places requiring fresh air and constant temperature and humidity.

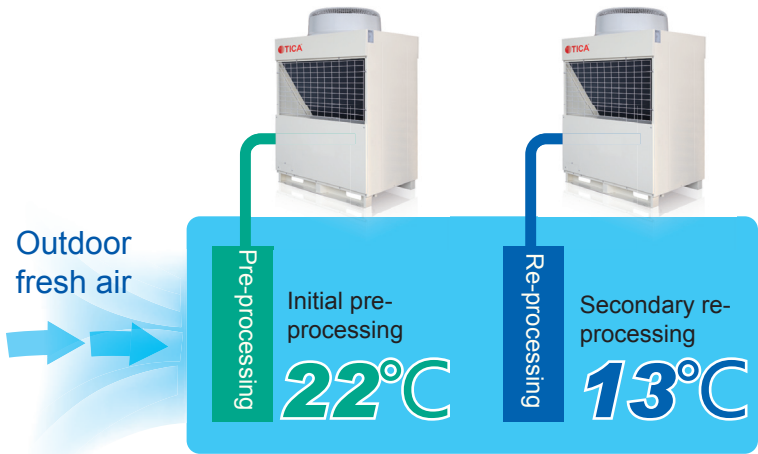

Stable control of temperature and humidity

Equipped with Emerson's world-leading digital variable-capacity compressor, the unit features 10-100% capacity regulation and rapid response, ensuring that the supply air temperature is aligned with the set point and both temperature and humidity are constant indoors.

Energy-efficient

At partial load, the output capacity of the digital variable-capacity compressor becomes smaller, the motor efficiency and the heat transfer efficiency of the IDU and ODU are improved, and the integrated part load value (IPLV) is generally higher than that of the ordinary fixed-capacity, direct expansion unit by more than 30%. Compared with a single-tier coil system, the two-tier coil system boasts increased evaporation temperature and increased energy efficiency of 20%.

Ordinary compressor
0-50%-100% range-based control

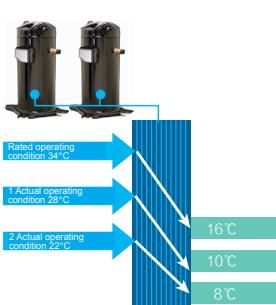

Digital compressor
10-100% variable capacity

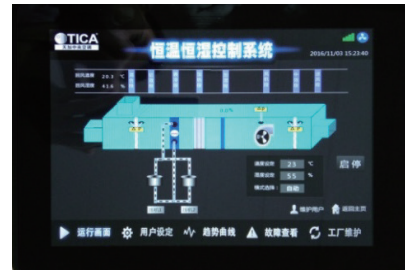
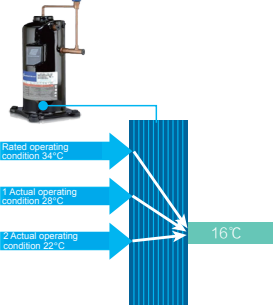

Compact structure

The IDU size is optimally designed. Specifically, it is designed in the form of two-tier, direct expansion coils rather than single-tier coils, which makes the coil system much smaller and IDU cabinet more compact.

Intelligent control system

TICA's self-developed controller, supplemented by a capacitive touch screen, is easy to operate and user-friendly; equipped with multiple controls and interlocking features, it saves the trouble of further tailor-made development on site; with multiple protection and alarm functions, it can ensure the stable operation of the unit.

Model selection of fresh air, constant temperature and constant humidity air conditioner

Air flow	ESP	Model				Refrigerant	Cooling capacity	Heating capacity (Heat pump type)	Humidifying capacity	Type	Electrical heating capacity							Applicable area
		IDU	ODU	Electric heating capacity of a cooling-only unit (at different lowest air inlet temperatures in winter)							Electric heating capacity of a heat pump unit (in the case of winter, winter preheating and summer reheating are both used for defrosting compensation)							
				-15°C								-5°C		0°C			Preheating capacity in winter	
m ³ /h	Pa	TBC	TDMV***V6H4ACF	TDMV***V6H4ACD	-	kW	kW	kg/h	-	kW	kW	kW	kW	kW	kW	kW		kW
1700	600	0711	-	080	R410A	25	-	17	Electrode humidification	12	12	9	9	15	-	-	40	
1900		0711	-	100		29	-	19		14	14	10	10	17	-	-	45	
2250		0711	-	120		35	-	22		16	16	12	12	20	-	-	54	
2500		0711	-	140		41	-	25		18	18	13	13	23	-	-	60	
3000		0711	-	160		47	-	30		21	21	16	16	27	-	-	71	
3900		1012	-	100*2		58	46	39		28	28	21	21	35	13	13	93	
4500		1012	-	120*2		70	53	45		32	32	24	24	41	15	15	107	
5200		1012	-	140*2		82	61	52		37	37	28	28	47	18	18	124	
6000		1012	-	160*2		94	71	60		42	42	32	32	55	20	20	143	
6700		1012	120*2	120		105	79	67		47	47	36	36	61	23	23	160	
7500		1012	120*2	160		117	88	75		53	53	40	40	68	25	25	179	
8000		1012	160*2	160		141	94	80		57	57	43	43	73	27	27	190	
10500		1115	160*2	120*2		164	124	105		74	74	57	57	95	35	35	250	
11500		1115	120*3	120*2		175	136	115		81	81	62	62	105	39	39	274	
13500		1317	160*3	120*2		211	159	134		95	95	73	73	123	45	45	321	
15500		1317	160*3	160*2		235	183	154		110	110	83	83	141	52	52	369	
18500		1319	160*3	160*3		282	218	184		131	131	100	100	168	62	62	440	

Typical function section configuration 1: air inlet, primary efficiency filter, (preheating in winter), fan, flow equalization, medium efficiency filter, direct expansion, reheating, humidification, and air outlet;
 Typical function section configuration 2: air inlet, primary efficiency filter, (preheating in winter), direct expansion pre-cooling/heating, fan, flow equalization, medium efficiency filter, direct expansion re-cooling/heating, reheating, humidification, and air outlet;

Notes:

- Rated outdoor parameters: ambient dry bulb temperature in summer of 34°C and wet bulb temperature of 28°C; outdoor dry bulb temperature in winter of 5°C; Rated indoor parameters: indoor dry bulb temperature of 25°C and relative humidity of 55% (temperature setting range at 16-26°C and humidity setting range at 35-70%);
- The heating capacity set forth in the table is the actual capacity required to reach the desired indoor temperature in winter;
- In heating mode, inlet air temperature should be preheated to at least 0°C;
- During winter, a heat pump unit is likely to undergo temporary fluctuations on temperature and humidity; When the dry bulb temperature of fresh air is below -10°C or when only one ODU is implemented, it is not recommended to use heat pump unit;
- The above table is for reference only. If there are any discrepancies relating to specific functions and parameters, please contact TICA.

Specifications of digital variable-capacity constant temperature and humidity control system (parameters and configuration)

Product Type		Digital Variable-capacity Direct Expansion Unit	
IDU	Model		DHD
	Cooling capacity range (kW)		25~282
ODU	Model code		TDMV
	Cooling and heating type		Cooling-only/heat pump
Temperature	Scope		16-26°C
	Precision		±1°C
Humidity	Scope		35% to 70%
	Precision		±5%
Unit configuration	Refrigerant		R410A
	Electric heater		Standard
	Electrode humidifier		Standard
	Humidification signal		Analog (0-10V)
Man-machine interface	Type		Capacitive touch screen
	Local touch screen		Standard, external placement allowed
Main controller type		Single-chip microcomputer	
Operating mode		Cooling/heating	
Timed on/off		Yes	
RS485 monitoring interface		Yes	
Monitoring dry contact	Remote start/stop		Yes
	Operating status		Yes
	Fault state		Yes
Control cabinet housing type			Standard indoor type, outdoor type optional
Fan motor control function		Blower motor	
Heating/humidifying control functions	Electric heating control	Yes	Electric reheater -- 1:2:4
	Electrode humidification control	Yes	Analog 0-10V With power air switch for humidification
	Electrode humidification changed to electric heating humidification		Yes
Interlocking passive dry contact	Exhaust fan interlock		Yes
	Fresh air valve interlock		Yes
	Fire valve interlock		Yes
	Firefighting monitoring interlocking		Yes
Protection functions	Wind break protection (including the differential pressure switch)		Yes
	Over-temperature power-off protection of electric heater		Yes
	Primary/medium/high efficiency filter alarm (excluding the differential pressure switch)		Yes
	Emergency stop button		Yes

Notes:

- The above table lists the standard configuration of digital variable-capacity constant temperature and humidity control system. For custom-made requirements, please consult TICA.
- The above table lists the control precision of temperature and humidity under standard air return condition. For the control precision under fresh air condition, please consult TICA.

Precision Constant Temperature and Humidity Air Conditioner

High-precision constant temperature and constant humidity air conditioner is required for scenarios like a test lab or optical instruments plants.

With its precise regulating power, the digital variable-capacity direct expansion unit can greatly improve accuracy of the control of indoor temperature and humidity.



Paper detection

Dry bulb temperature: $23\pm 1^{\circ}\text{C}$
Relative humidity: $50\pm 2\%$



Fiber detection

Dry bulb temperature: $20\pm 1^{\circ}\text{C}$
Relative humidity: $65\pm 2\%$

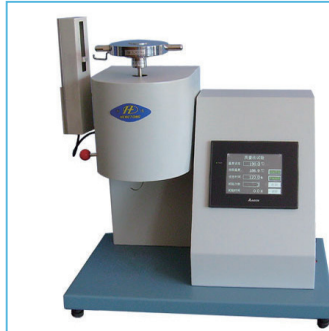

Plastic detection

Dry bulb temperature: $20\pm 1^{\circ}\text{C}$
Relative humidity: $50\pm 3\%$



Optical instrument manufacture

Dry bulb temperature: $20\pm 0.5^{\circ}\text{C}$
Relative humidity: $50\pm 3\%$

Specifications of precision constant temperature and constant humidity air conditioner

Model	TBC	0808	0810	0810	1012	1012	1115	1115	1317	1319	1319
Air flow	CMH	3000	4000	5000	6100	8000	10000	12000	16000	18000	20000
ESP	Pa	350	400	450	500	550	600	650	650	650	650
Typical function section configuration		Mixing, primary efficiency filter, direct expansion, reheating, electrode humidification, fan, flow equalization, medium efficiency filter, air outlet									
Cooling capacity	kW	15	20	29	35	47	58	70	94	105	141
Heating capacity	kW	17	22	32	38	51	64	76	102	114	153
Reheating capacity	kW	9	12	16	18	24	30	36	48	54	60
Humidifying capacity	kg/h	5	8	8	15	15	15	25	25	35	45
Recommended ODU models	TDMV*** V6H4ACD	080	080	100	120	160	100×2	120×2	160×2	120×3	160×3
		Multiple IDUs may share one ODU depending on actually required cooling capacity (TDMV080-160)									

Notes:

- The cooling capacity is tested under the nominal air flow, when the indoor dry/wet bulb temperature is $23/17^{\circ}\text{C}$ and the outdoor dry/wet bulb temperature is $35/24^{\circ}\text{C}$.
- The accuracy of indoor temperature and humidity is related to the times of air exchange, the structure of air flow and the structure of room enclosure. The suggestions are as follows: When the accuracy of temperature is $\pm 1^{\circ}\text{C}$ and the relative humidity is $\pm 5\%$, the times of air exchange are 15-20; when the accuracy of temperature is $\pm 1^{\circ}\text{C}$ and the relative humidity is $\pm 2\%$ (or temperature accuracy $\pm 0.5^{\circ}\text{C}$, relative humidity $\pm 3\%$), the times of air exchange are 20-30. Air flow structure: air supply via perforated plate, air supply from the top and air return from the bottom, air supply speed at 0.25-0.4m/s. The enclosures should have no windows and few doors;
- If air change ratio or other operating conditions vary, the required air flow may be inconsistent with cooling capacity parameters as set forth in the above table. The design plan may be adjusted according to the customer's needs. For details, please contact TICA.

Low Temperature Deep Dehumidification Air Conditioner

For capsule production and storage, lithium battery manufacturing, dairy products processing, and some sterile preparations manufacturing industries that require relatively low humidity (30-45%), the traditional rotating-wheel dehumidification is proved to be rather energy-intensive; for the cold processing of food that requires relatively low temperature (15-20°C), an average refrigerating air conditioner would have to reduce the supply air temperature to a very low point. If such air conditioner is not maintained properly, it may freeze easily.



Cold processing of food

Dry bulb temperature: 18°C
Relative humidity: 55%



Capsule and sterile drugs manufacture

Dry bulb temperature: 24°C
Relative humidity: 40%



Lithium battery manufacture

Dry bulb temperature: 24°C
Relative humidity: 40%

Low temperature air supply without freezing

When the filter becomes dusty or the indoor or outdoor conditions vary, the required cooling quantity is less than the design value. Under such circumstance, an average direct expansion unit is unable to reduce its output, and therefore the supply air temperature is relatively low and when the unit operates in cooling mode at a low temperature the evaporator is easily freezing. Once the evaporator is frozen, its air resistance is increased and air flow is decreased. As a result, freezing is getting even more serious, and in severe cases the system would break down. However, a digital variable-capacity direct expansion unit can accurately output the required cooling quantity in the range of 10-100%, and is therefore unlikely to result in freezing due to excessive cooling. In this way, it can ensure stable operation of the unit and a supply air temperature as lowest as 8°C.

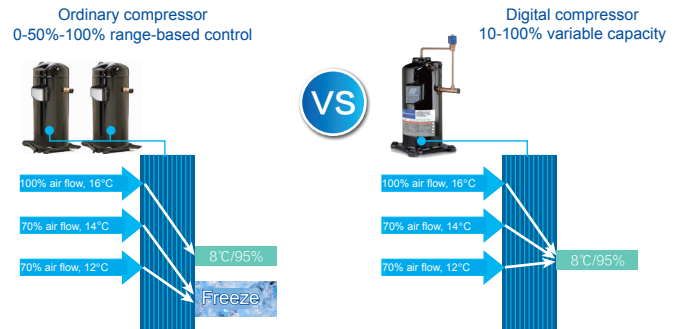

Due to its advantage of non-freezing operation at low temperature, the digital variable-capacity direct expansion unit can be widely used in low humidity environment such as pharmaceuticals, lithium electricity and food processing.

Taking a unit with an air volume of 7500cmh as an example, the unit is 50% more energy efficient compared with the traditional rotating-wheel dehumidification.

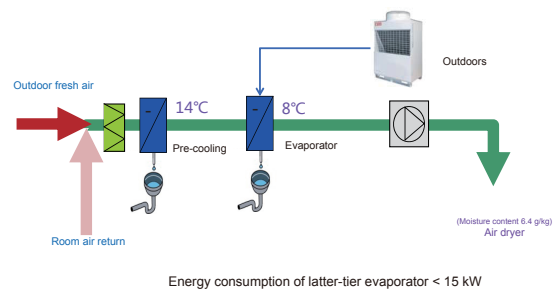
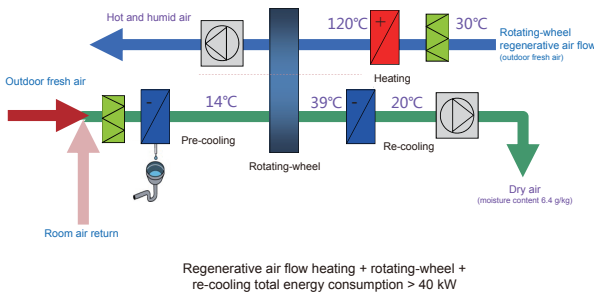

The unit can also be used in special low-temperature air-conditioning places requiring room temperature to be kept at 10-18°C; for any specific low humidity and low temperature applications, please consult TICA.

Air Conditioner for Rapid Cooling of a Cardiac Surgery Operating Room

TICA's air conditioning unit specially designed for rapid cooling has the digital direct expansion coil equipped next to the behind conventional water-cooled coil. When rapid cooling is required, it uses the water-cooled coil for pre-cooling and the rapid cooling coil for deep cooling and dehumidifying, so as to achieve the desired indoor temperature and humidity in a very short period of time.

01 Rapid cooling

Refrigerant (R410A) would evaporate and cool down the room by just one click, drying the room and reducing the temperature to below 8°C

02 Precise control

With Emerson (Copeland)'s patented digital variable-capacity compressor and its stepless regulation with the range of 10-100%, the unit can implement output to the full at the beginning and gradually reduce cooling capacity when it comes near the target, hence delivering cooling quickly yet reliably for a cardiac surgical operating room.

03 Perennial cooling

The controllable digital compressor, DC brushless outdoor fan, and EXV are combined to ensure that the unit achieves stable cooling at very low ambient temperature and therefore meets the cooling requirements throughout the year for a cardiac surgical operating room.

04 Stable and reliable

Compared with an inverter unit, the digital variable-capacity compressor has no electromagnetic interference and therefore could maintain stable operation.

05 Clean

TICA's unit specially designed for the cardiac surgical operating room is also EUROVENT and AHRI certified, featuring ultra-low air leakage rate (L1) and no-cold bridge (TB1). The unit is flat inside so that it does not collect dust, which could ensure clean air supply.

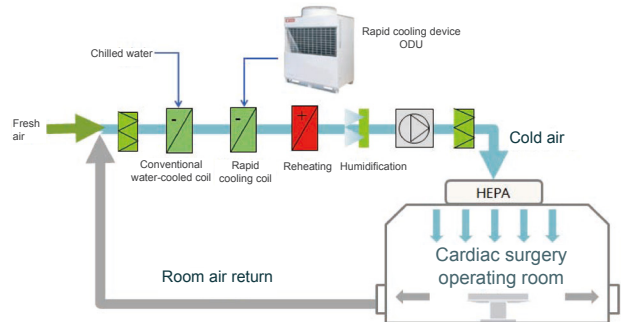

Specifications

Primary air return				
Model	TBC	1217	1317	1319
Air flow	CMH	9000	11000	13000
ESP	Pa	700	700	700
Cooling capacity of direct expansion coil	kW	27	33	38
Reheating capacity	kW	25	31	36
Humidifying capacity	kg/h	9.2	11.2	13.2
Recommended ODU models	TDMV	100	120	140
Typical function section configuration	Mixing, fan, flow equalization, primary efficiency filter, medium efficiency filter, cooling coil, direct expansion coil, overhaul, hot water heating, electric heating, humidification, air outlet			
Secondary air return				
Model	TBC	1217	1317	1319
Air flow	CMH	9000	11000	13000
ESP	Pa	700	700	700
Cooling capacity of direct expansion coil	kW	20	22	26
Reheating capacity	kW	16	19	22
Humidifying capacity	kg/h	9.2	11.2	13.2
Recommended ODU models	TDMV	100	120	140
Typical function section configuration	Mixing, primary efficiency filter, cooling coil, direct expansion coil, overhaul, hot water heating, electric heating, humidification, secondary air return, fan, flow equalization, medium efficiency filter, air outlet			

1. Rated outdoor parameters: outdoor operating condition in summer: 35°C/28.3°C; outdoor operating condition in winter: -5°C/73%;
2. Rated indoor parameters: indoor operating condition: 24°C/55%; rapidly cooled to 16°C/60% and heated to 29°C
3. Pre-handled to indoor operating condition (24°C/55%) isoenthalpy in summer and to 10°C in winter
4. The ambient temperature for cooling operation of ODU ranges from -5°C to 45°C.
5. If the operating condition varies, the parameters will change accordingly. For details, please contact TICA.

ODU Specifications

ODU specifications for standard module

Model	TDMV	080 V6H4ACD	100 V6H4ACD	120 V6H4ACD/F	140 V6H4ACD	160 V6H4ACD/F
Cooling capacity	kW	25	29	35	41	47
Heating capacity	kW	27	32	38	45	51
Power input (cool)	kW	7.8	9.2	11	13.6	15.6
Maximum operating current	A	28.4	28.4	28.4	45.2	45.2
Cooling/heating capacity range	10%-100%					
Ambient temperature for operating	Cooling: -5-45°C; Heating: -10-24°C					
Size per unit	L×W×H	992×845×1840			1292×845×1840	
Net weight per unit	kg	300			395	
Refrigerant charge per unit (R410A)	kg	10.6			12	
Connecting pipe: liquid/gas pipe diameter	φ mm	12.7/28.58 (one liquid pipe and one gas pipe for each ODU)				

- Cooling capacity test conditions: ambient dry bulb temperature: 35°C; air inlet dry/wet bulb temperature of IDU: 27/19.5°C; 100% output;
- Heating capacity test conditions: ambient dry/wet bulb temperature: 7/6°C; air inlet dry bulb temperature of IDU: 20°C; 100% output;
- One ODU from a single module can connect up to three IDUs at most.

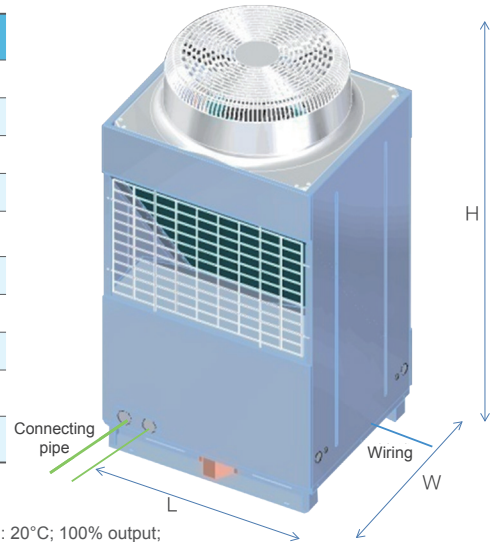

Standard modules can be combined to form larger cooling capacity as follows:

Methods of combination	TDMV-V6×Qty	100×2	120×2	140×2	160×2	120×3	160×3
Total cooling capacity	kW	58	70	82	94	105	141
Total heating capacity	kW	64	76	89	102	114	153

- When ODUs adopt combination mode, the IDUs should accordingly adopt multi-system design. The number of IDU and ODU connecting pipes should be consistent with that of ODUs. For example, for TDMV360, which is composed of 3 sets of TDMV120, three sets of connecting pipes between IDU and ODU are required.
- When ODUs adopt combination mode, they should not connect to multiple IDUs.

When the ambient temperature or the supply air temperature has deviated from the rated value, the ODU will be revised according to the cooling capacity correction factor for ODU as set forth in the table below:

ODU ambient temperature (°C)	26	28	30	35	38	40	43	
Cooling capacity correction coefficient K1	1.11	1.08	1.06	1	0.96	0.94	0.88	
Air outlet temperature of IDU evaporator (°C)	5	7	9	11	13	15	18	20
Cooling capacity correction coefficient K2	0.65	0.7	0.78	0.86	0.95	1	1.12	1.2

E.g.: If one unit operates at an actual ambient temperature of 30°C, and the IDU requires an air supply temperature at 18°C, then ODU's cooling capacity correction coefficient =K1*K2=1.06*1.12=1.19.

When the IDU and ODU connecting pipe is too long or the height difference of IDU and ODU is too large, the cooling capacity will be affected and shall be corrected according to the table below.

Correction coefficient	One-way piping length (m)						
	50	60	70	80	90	100	
Level difference between IDU and ODU (m) (ODU is above the IDU)	50	93.30%	91.70%	90.40%	89.10%	88.10%	87.50%
	40	93.40%	91.80%	90.50%	89.20%	88.20%	87.60%
	30	93.60%	91.90%	90.60%	89.30%	88.30%	87.70%
	20	93.70%	92.00%	90.70%	89.40%	88.40%	87.80%
	0	94%	92.50%	91.2%	90%	88.50%	89%
Level difference between IDU and ODU (m) (IDU is above the ODU)	20	93.20%	91.90%	90.50%	89.40%	88%	88.40%
	30	93.00%	91.60%	90.20%	89.10%	87.80%	88.20%
	40	92.70%	91.40%	90.00%	88.90%	87.60%	88%

- For TDMV120 and smaller models, when main piping length is smaller than or equal to 100m, liquid pipe diameter is 12.7 and gas pipe diameter is 28.58;
- For TDMV140 and TDMV160, when main piping length is smaller than or equal to 40m, liquid pipe diameter is 12.7 and gas pipe diameter is 28.58; when main piping length is greater than 40m, liquid pipe diameter is 15.88 and gas pipe diameter is 31.7.

IDU Air Flow Table and Electrical Diagram

IDU air flow table (CMH)

Table 1) The IDU coil boasts large enthalpy difference so that it is suitable for fresh air conditions. (when air inlet/outlet enthalpy difference > 30kJ/kg or IDU coil's cooling capacity/air flow > 10W/CMH)

No.	ODU Specifications	IDU Model	Windward Fan Speed of the Coil (m/s)							
			1	1.2	1.5	1.8	2	2.2	2.5	2.8
1	Single ODU (≤160)	TBC0711	1554	1865	2332	2798	3109	3420	3886	4353
2	Dual ODUs (100*2~160*2)	TBC1014	3424	4108	5135	6162	6847	7532	8559	9586
3	Triple ODUs (120*3~160*3)	TBC1217	4957	5948	7435	8923	9914	10905	12392	13879

Table 2) The IDU coil boasts small enthalpy difference so that it is suitable for ordinary air return conditions, fresh air pre-handling conditions, and two-tier evaporator (air inlet/outlet enthalpy difference < 30kJ/kg or cooling capacity/air flow passing through IDU coil < 10W/CMH).

No.	ODU Specifications	IDU Model	Windward Fan Speed of the Coil (m/s)							
			1	1.2	1.5	1.8	2	2.2	2.5	2.8
1	Single ODU (≤160)	TBC0808	1474	1769	2211	2653	2948	3243	3685	4127
2		TBC0810	1950	2339	2924	3509	3899	4289	4874	5459
3		TBC1012	2954	3544	4430	5316	5907	6498	7384	8270
4	Dual ODUs (100*2~160*2)	TBC1012	2954	3544	4430	5316	5907	6498	7384	8270
5		TBC1115	4115	4938	6172	7407	8230	9053	10287	11521
6		TBC1317	5633	6759	8449	10139	11265	12392	14082	15772
7	Triple ODUs (120*3~160*3)	TBC1115	4115	4938	6172	7407	8230	9053	10287	11521
8		TBC1317	5761	6913	8641	10369	11521	12674	14402	16130
9		TBC1319	6584	7900	9876	11851	13167	14484	16459	18434

Example 1: If air flow 5000CMH, cooling capacity requirement 90kW and ODU specifications TDMV160*2, cooling capacity/air flow ratio =18W/CMH, then select TBC1014 in Table 1.

Example 2: If air flow 5000CMH, cooling capacity requirement 32kW and ODU specifications TDMV120*1, cooling capacity/air flow ratio =6.4W/CMH, then select TBC0810 or TBC1012 in Table 2. Both models can meet requirements, but the TBC0810 is more cost effective.

Electrical diagram

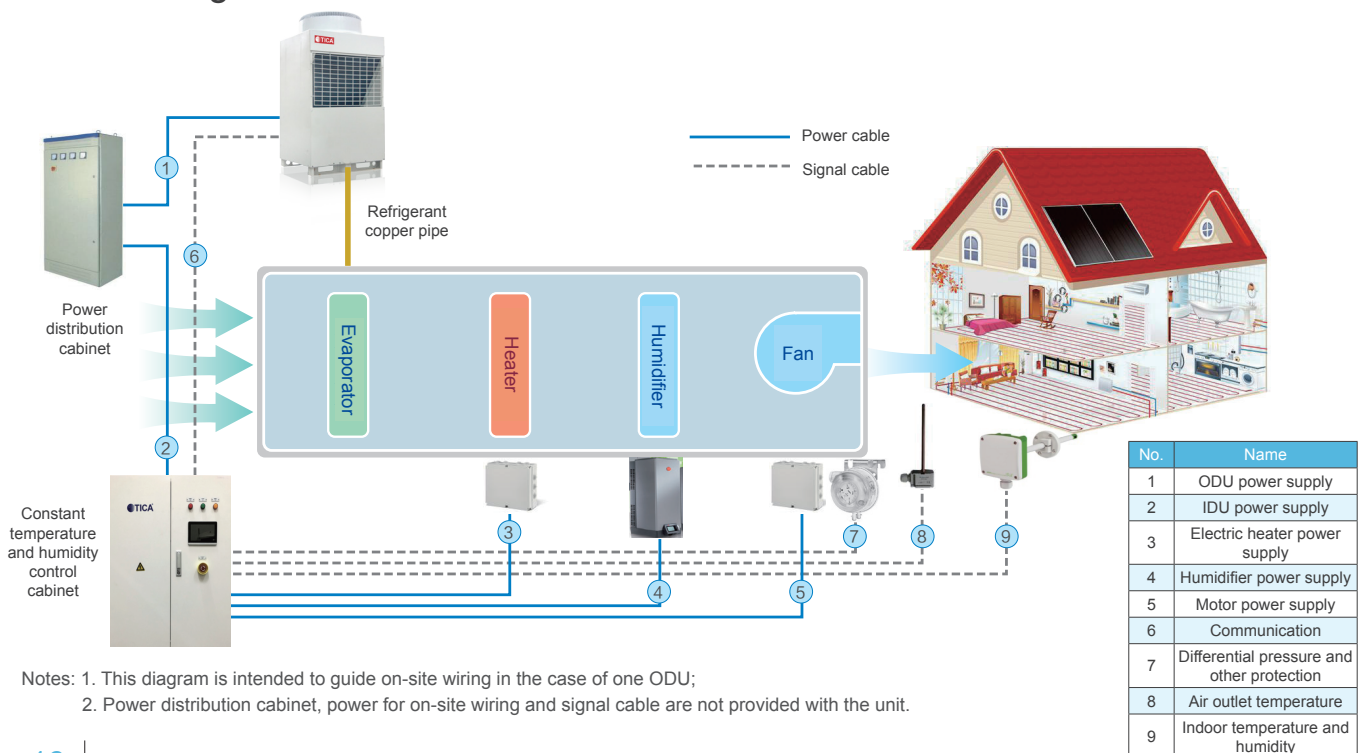

Five-year Warranty

Digital variable-capacity DX air handling unit (ODU)

Monthly inspection	1. Check whether the unit generates any alarm
	2. Check for any abnormal compressor or fan noise
	3. Check for odors inside the startup cabinet and control cabinet
	4. Check whether the temperature sensor and temperature probe are securely fixed
	5. Check for any appearance damage of the unit and whether heat exchanger or discharge fan is blocked
	6. Check for leakage in the refrigerant loop (whether there is any greasy dirt or sound of leak)
	7. Check whether the control cabinet is securely wired, whether wiring terminals are clean, whether the unit leaks, and whether contactor works properly

Notes:

1. Monthly inspections are to be performed and recorded by the user.
2. The replacement of consumable parts and materials is determined by the service life or operation duration of the unit. For units that operate all year around and those for the purpose of process, the operation duration should prevail; for units under normal operation and those for comfort, the service life should prevail.
3. It is recommended that the unit should be fully maintained every three years or every 3,000 hours of machine operation. For clean units with purification requirements, shorten the maintenance time interval according to the user's cleaning requirements. For units with severe environmental conditions, they should be maintained monthly according to the inspection conditions.

Digital variable-capacity DX air handling unit (IDU)

Inspection items			Monthly	Quarterly	Year	Concerns
Air-side cabinet	Air inlet section	Check whether the filter is dirty and clogged.	★	★	★	The final resistance of the unit reaches the requirements. (For the alarm values, see the technical manual.)
	Coil Section	Cooling coil	☆	☆	★	Check whether the surface is full of dust, oil stain, impurities, etc.
		Fluorine coil	☆	☆	☆	
		Steam coil	☆	☆	★	Check whether the steam gauge pressure of the gas supply pressure is between 0.02 Mpa and 0.4 Mpa. Check whether the steam trap is dirty and clogged.
		Condensate water drain pan and drainage pipe	☆	☆	☆	Check whether they are dirtied and clogged. Check whether water drainage is smooth.
	Humidification Section	Electrode humidifier	★	★	★	Clean the humidifying barrel per 200 hours. Replace the electrode every 2000 hours.
		Dry steam humidifier	☆	☆	☆	
	Fan section	Measure the belt tension.	☆	☆	☆	Check for cracks.
Inspection of fan and motor bearing		★	★	★	Normally, the lubricating grease should be replaced after the fan has operated for about 1500 hours; if the fan operates continuously for 24 hours, replace the lubricating grease every 500 - 700 hours of operation.	
Electrical control and electrical	Electrical control cabinet	Fuse	☆	☆	☆	Disconnection
		Contactor	☆	☆	☆	Serious contact electrocorrosion or noise during running.
		Sensor	☆	☆	☆	Measured value still varies from the actual value even after calibration.
		High pressure switch	☆	☆	☆	Controller false alarm.
		Check whether the wiring point is loose.	★	★	★	The contactor gets loose or can flexibly rotate when turning the connecting cable.
		Checking power supply	★	★	★	Rated voltage $\pm 10\%$, phase-to-phase unbalance $< 2\%$.
		Checking phase	☆	☆	☆	No phase loss or reverse phase

Notes:

- ① ★----Required maintenance or replacement items; ☆---- Determine the maintenance items according to actual conditions.
- ② Daily and monthly inspections should be performed and recorded by the user.
- ③ The replacement of consumable parts and materials is determined by the service life or operation duration of the unit. For units that operate all year around and those for the purpose of process, the operation duration should prevail; for units under normal operation and those for comfort, the service life should prevail.
- ④ It is recommended that the unit should be fully maintained every one year or every 1000 hours of machine operation. For clean units with purification requirements, shorten the maintenance time interval according to the user's cleaning requirements. For units with severe environmental conditions, they should be maintained monthly according to the inspection conditions.

Unit Installation

- The air conditioning unit should be installed on a horizontal base.
- A sufficient space should be reserved around the unit, especially at the access door side of unit pipes, fan and motor, so as to facilitate routine unit inspection and regular maintenance.
- The condensate water outlet must be equipped with a water seal before it connects to the external pipe.
- The standard power supply for the unit is a three-phase five-wire AC power system (380V 3N-50 Hz). Before power-on, check whether the voltage is proper, whether the phase is missing and whether the three phases are balanced. After connecting the power supply, start the motor first, and check whether the fan rotates in the right direction.
- The motor of air conditioning unit should be connected to a power supply with overload protection.
- Flexible connection should be adopted between the air conditioning unit and the external air duct to avoid vibration transmission;
- The air discharged by the ODU cannot flow back (i.e., discharge short circuit is prevented), and the air outlet is unblocked.
- The installation site of ODU is free of waste, oil, and corrosive gas.

Reference Projects

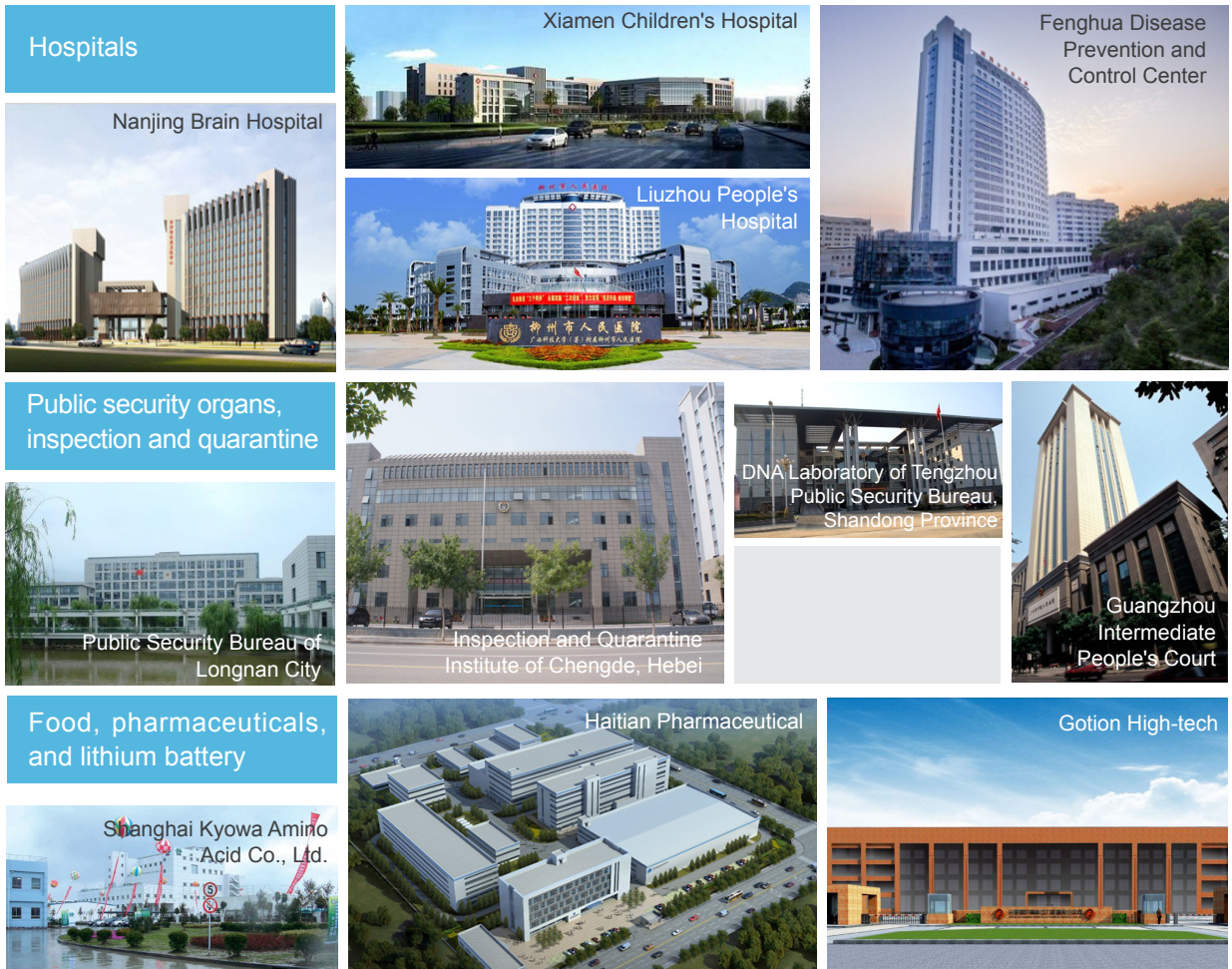



Follow the WeChat Official Account of TICA

4008-601-601

Nanjing TICA Climate Solutions Co., Ltd.
Address: No. 6, Hengye Road, Nanjing Economic and
Technological Development Zone, Nanjing, Jiangsu, China
Post Code: 210046
Tel: 86-25-85326977
E-mail: tica@ticachina.com

Note: Due to the continuous improvement and innovation of TICA's products, the model numbers, specifications and parameters in this document are subject to change without notice.